

# Lutron Tensioned Shades

**Available For:**  
Sivoia QED®  
Sivoia® QS  
Sivoia® QS Wireless



Tensioned shades from Lutron combine electronic drive technology with a unique tension system. Fabric is kept taut and parallel to skylights and angled windows regardless of slope. Now, defy gravity and control daylight through skylight and angled window applications to reduce glare and save energy by reducing heat gain.

## **Aesthetics**

- Product fascia eliminates gaps around fabric
- Concealed cable guides maximize view when open
- Wide variety of high performance fabrics

## **Design**

- Unique tension-absorbing frame eliminates stress on the surrounding structure
- Reliable performance under extreme temperatures

## **Control**

- Smooth, quiet, precise movement of shades for skylight and angled windows
- One-touch control through keypad, IR, or RF remote
- Seamless integration with other Lutron products and lighting controls



## **Installation**

- Inside, recessed, and surface mounting options
- Pre-assembled shipping available for shade sizes up to 30 sq. ft. (2.8 sq. m)

# Lutron Tensioned Shades

## Installation angles

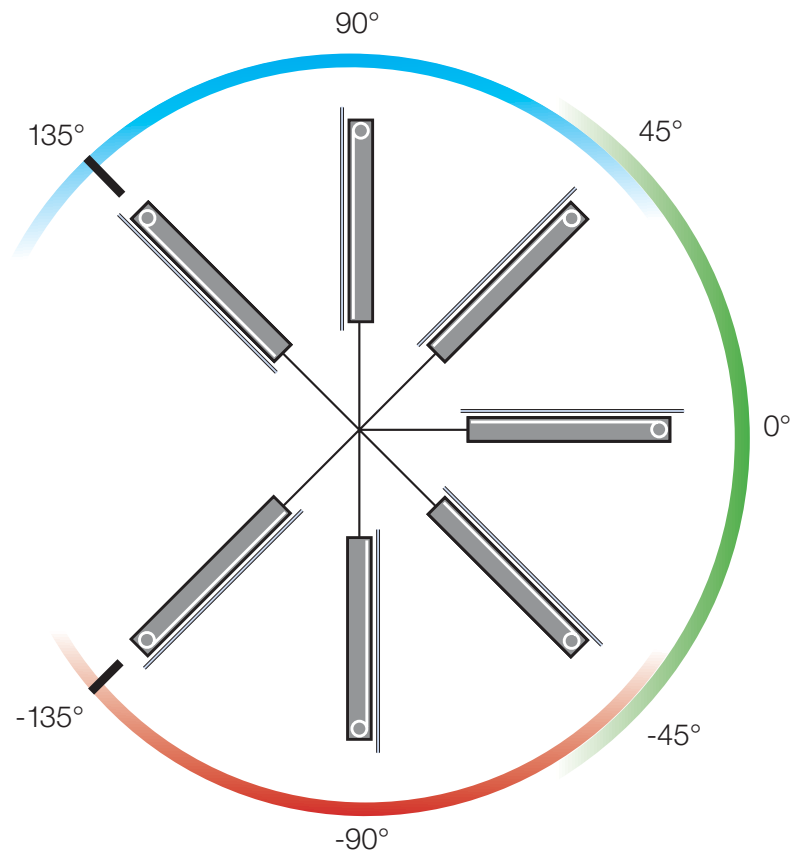

Lutron tensioned shades allow for flexible installation at any angle between  $-135^{\circ}$  and  $135^{\circ}$  with consistent aesthetic results. Shade can close from top to bottom, or from the bottom up, with fabric unrolling closest to the window.

-  Angled shades
-  Skylight shades
-  Bottom-up shades



## System parameters

This chart illustrates dimensions of the tensioned shade system. The system contains the frame and shade.

-  Minimum system size:  
2 ft. wide x 3 ft. long (610 mm x 914 mm)
-  Maximum system size:  
8 ft. wide x 12 ft. long  
(2438 mm x 3658 mm)
-  Frame thickness:  
Drive side: 4.65 in. (118 mm)  
Non-drive sides: 2.25 in. (57 mm)

Note: Tensioned shade dimension limitations are a function of fabric selection and application angle. Please consult the Shade Configuration Tool (SCT) or Customer Service for details.

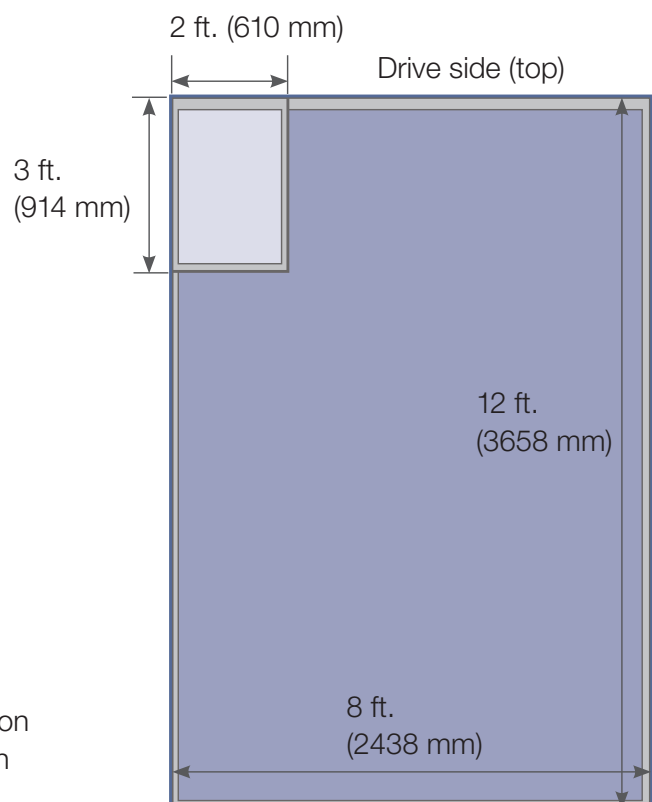

## Mounting options

Lutron tensioned shades can be installed inside of, recessed into, or on the surface\* of the skylight or window opening.

### Skylight cross-section

Inside mount  
(standard)

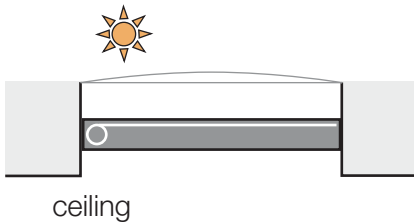

Recessed inside mount  
(new construction)

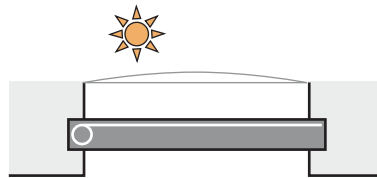

Surface mount (ceiling)\*  
(ideal for retrofit)

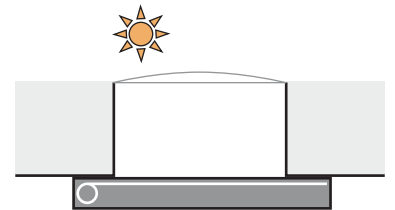

### Skylight and window room view

Inside mount

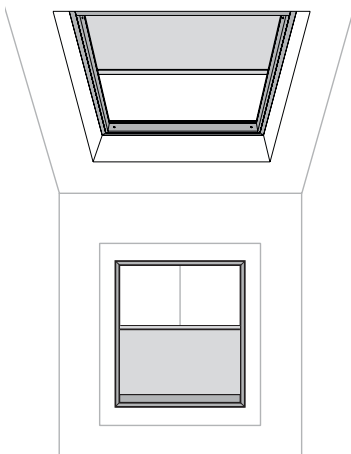

Recessed inside mount

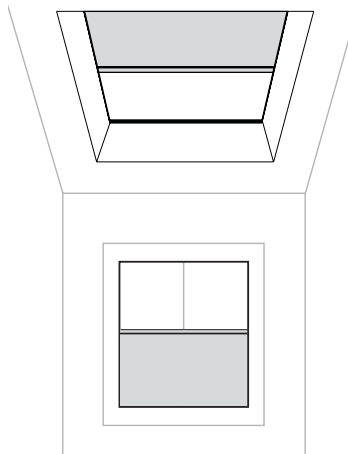

Surface mount (ceiling)\*

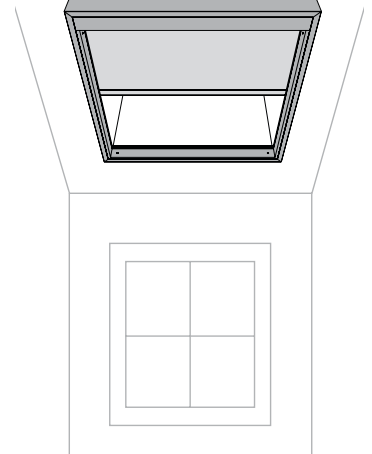

### Frame specifications

System is concealed within its frame. Frame thickness and depth are standard regardless of system size. Pre-assembled shipping available:\*\* Available in white and anodized aluminum.

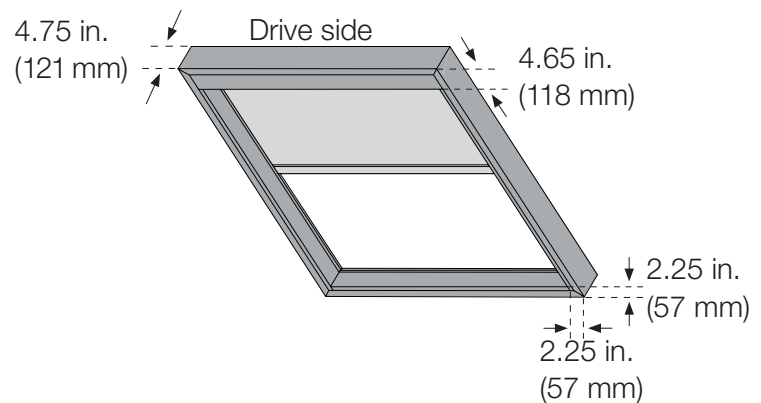

\* Surface mount recommended for skylight applications only

\*\* Shade sizes up to 30 sq. ft. (2.8 sq. m)

# Lutron Tensioned Shades

## Fabric options

We offer a wide variety of sheer, dim-out, and blackout fabrics to enhance the décor of commercial and residential spaces. The fabric offering meets the highest standards of enduring extreme temperatures while delivering performance and reliability.

Category	Family	Fabric	Openness Factor (%)	Number of Colors	Stocking Category*
<b>Sheer</b>	SheerShade®	Basketweave 90	1, 3, 5, 10	10	Stocked, Premium, and Custom
		Basketweave 2000	5, 10	10	Custom
		Basketweave ES	1, 3, 5, 10	5	Premium
		Basketweave MS	3, 5	20	Premium
		Basketweave TS	1, 3	9	Premium
	Designer	MS Designer	3, 5	10	Custom
	Dual-sided	Basketweave 27	1, 3, 5, 10	5	Stocked
		Basketweave ST	5	10	Custom
		Basketweave Silver	4	10	Premium
<b>Dim-out</b>	Privacy	Translucent P	1	5	Stocked
<b>Blackout</b>	Standard	Standard	0	6	Stocked and Premium
	Dual-sided	Premiere	0	12	Stocked and Premium

\* Stocking categories refer to the lead time from receipt of order. Consult your qualified shade provider or the SCT for additional information.

[www.lutron.com/shadingsolutions](http://www.lutron.com/shadingsolutions)

World Headquarters 1.610.282.3800

Technical Support Center 1.800.523.9466 (Available 24/7)

Customer Service 1.888.LUTRON1

